

Xantrex™ XW MPPT 80 600

Installation Guide

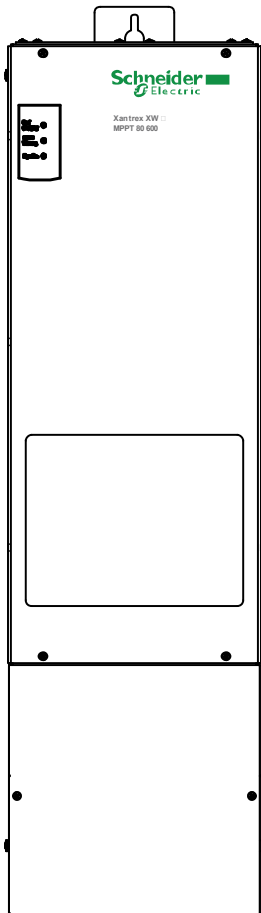

Xantrex XW MPPT 80 600

Installation Guide

Trademarks

Schneider Electric, the **Schneider Electric logo**, **Xantrex**, and **Xanbus** are trademarks or registered trademarks of the Schneider Electric group of companies. Other trademarks, registered trademarks, and product names are the property of their respective owners and are used herein for identification purposes only.

Notice of Copyright

Copyright © 2010 Xantrex Technology Inc. All rights reserved. No part of this document may be reproduced in any form or disclosed to third parties without the express written consent of:

Xantrex Technology Inc.

161-G South Vasco Road

Livermore, California USA 94551

Xantrex Technology Inc. reserves the right to revise this document and to periodically make changes to the content hereof without obligation or organization of such revisions or changes unless required to do so by prior arrangement.

Exclusion for Documentation

UNLESS SPECIFICALLY AGREED TO IN WRITING, XANTREX TECHNOLOGY INC. ("XANTREX")

(A) MAKES NO WARRANTY AS TO THE ACCURACY, SUFFICIENCY OR SUITABILITY OF ANY TECHNICAL OR OTHER INFORMATION PROVIDED IN ITS MANUALS OR OTHER DOCUMENTATION;

(B) ASSUMES NO RESPONSIBILITY OR LIABILITY FOR LOSSES, DAMAGES, COSTS OR EXPENSES, WHETHER SPECIAL, DIRECT, INDIRECT, CONSEQUENTIAL OR INCIDENTAL, WHICH MIGHT ARISE OUT OF THE USE OF SUCH INFORMATION. THE USE OF ANY SUCH INFORMATION WILL BE ENTIRELY AT THE USER'S RISK; AND

(C) REMINDS YOU THAT IF THIS MANUAL IS IN ANY LANGUAGE OTHER THAN ENGLISH, ALTHOUGH STEPS HAVE BEEN TAKEN TO MAINTAIN THE ACCURACY OF THE TRANSLATION, THE ACCURACY CANNOT BE GUARANTEED. APPROVED XANTREX CONTENT IS CONTAINED WITH THE ENGLISH LANGUAGE VERSION WHICH IS POSTED AT WWW.SCHNEIDER-ELECTRIC.COM.

Date and Revision





November 2010 Revision A

Part Number

975-0540-01-01

Contact Information

www.schneider-electric.com

			
North America	1 650 351 8237 1 866 519 1470	1 925 245 1022	re.techsupport@schneider-electric.com
France	0 825 012 999		fr-re-techsupport@fr.schneider-electric.com
Deutschland	+49 (0) 180 575 3 575	+49 (0) 2102 404 7101	pv-service@de.schneider-electric.com
España	+34 902 101 813	+34 933 055 026	es-sat@es.schneider-electric.com
L'Italia	+39 035 4151111	+39 035415 3200	IT-pronto-contatto@it.schneider-electric.com

For other country details please contact your local Schneider Electric Sales Representative or visit our website at: <http://www.schneider-electric.com/sites/corporate/en/support/operations/local-operations/local-operations.page>

About This Guide

Purpose	The purpose of this Guide is to provide explanations and procedures for installing and troubleshooting the Schneider Electric Xantrex XW MPPT 80 600.
Scope	This Guide provides safety guidelines, detailed planning and setup information, procedures for installing the unit, and information about troubleshooting. It does not provide details about particular brands of photovoltaic (PV) panels or batteries.
Audience	<p>This Guide is intended for qualified personnel who need to install the unit. Qualified personnel have training, knowledge, and experience in:</p> <ul style="list-style-type: none">• Installing electrical equipment and PV power systems (up to 1000 V).• Applying all applicable installation codes.• Analyzing and reducing the hazards involved in performing electrical work.• Selecting and using Personal Protective Equipment (PPE). <p>Only qualified personnel should perform the installation, commissioning, and maintenance of the unit.</p>
Organization	<p>This Guide is organized into three chapters and one appendix:</p> <ul style="list-style-type: none">• Chapter 1 describes features and functions of the Xantrex XW MPPT 80 600.• Chapter 2 provides installation instructions for the Xantrex XW MPPT 80 600. Before installing the unit, read this entire chapter.• Chapter 3 contains information about identifying and resolving possible problems that may arise while using a Xantrex XW MPPT 80 600.• Appendix A provides the specifications for the Xantrex XW MPPT 80 600.
Conventions Used	<p>This Guide uses the term “unit” to refer to the Xantrex XW MPPT 80 600.</p> <p>This Guide uses the following conventions for conveying important safety related information:</p>

DANGER

DANGER indicates an imminently hazardous situation which, if not avoided, will result in death or serious injury.

WARNING

WARNING indicates a potentially hazardous situation which, if not avoided, can result in death or serious injury.

▲ CAUTION

CAUTION indicates a potentially hazardous condition which, if not avoided, can result in minor or moderate injury.

CAUTION

CAUTION without the exclamation symbol indicates a potentially hazardous situation, which, if not avoided, can result in equipment damage.

NOTICE

NOTICE indicates important information that you need to read carefully.

Important: These notes describe things which are important for you to know, but they are not as serious as a notice, caution, warning, or danger.

Abbreviations and Acronyms

CSA	Canadian Standards Association
DC	Direct Current
FCC	Federal Communications Commission
GFP	Ground Fault Protection
I _{sc}	Short circuit current rating of an PV panel under STC
LCD	Liquid Crystal Display
LED	Light Emitting Diode
MPP	Maximum Power Point
MPPT	Maximum Power Point Tracking
MSDS	Material Safety Data Sheet
NEC	US National Electrical Code NFPA-70
PV	Photovoltaic
STC	Standard Test Conditions specific to photovoltaic panels (1000 W/m ² , light spectrum AM 1.5 and 25 °C); panel nameplate ratings are based on STC and may be exceeded under other conditions.
UL	Underwriters Laboratories
VAC	Volts AC
VDC	Volts DC
VMPP	Voltage at Maximum Power Point
VOC	Open circuit voltage rating of a PV panel under STC

Related Information

You can find information about using the unit in the Xantrex XW MPPT 80 600 Operation Guide (Document Part Number 975-0560-01-01). It is provided with the unit and is also available at www.schneider-electric.com.

You can find more information about Schneider Electric as well as its products and services at www.schneider-electric.com.

Important Safety Instructions

General Safety Instructions

DANGER

HAZARD OF SHOCK, BURN, FIRE, AND EXPLOSION

This Guide contains important safety instructions that should be followed during the installation and maintenance of the Xantrex XW MPPT 80 600. Be sure to read, understand, and save these safety instructions

- All electrical work must be done in accordance with local electrical codes.
- To be installed and serviced only by qualified personnel equipped with appropriate personal protective equipment and following safe electrical work practices.
- Energized from multiple sources. Before removing covers, consult system diagram to identify all sources; de-energize, lock out, and tag out; and wait for two minutes for internal capacitors to discharge to a safe voltage.
- Before servicing, test using a meter rated at least 1000 VDC to make sure all circuits are de-energized.
- Provided with integral PV ground fault protection. Normally grounded conductors may be ungrounded and energized when a ground fault is indicated. Integral ground fault detection fuse is located under wiring compartment cover. Disconnect all sources of power before opening.

Failure to follow these instructions will result in death or serious injury.

WARNING

LIMITATIONS ON USE

Do not use the Xantrex XW MPPT 80 600 with life support equipment or other medical equipment or devices.

Failure to follow these instructions can result in death or serious injury.

WARNING

HAZARD OF ELECTRIC SHOCK

For installation indoors only. Do not expose unit to rain, snow, dust, or liquids of any type.

Failure to follow these instructions can result in death or serious injury.

Battery Safety Information

⚠ DANGER

HAZARD OF ELECTRIC SHOCK, BURN, FIRE, AND EXPLOSION

Batteries contain corrosive electrolyte and can give off explosive gases. Battery circuits present a shock and energy hazard. Observe proper precautions when working with batteries and battery circuits:

- Always wear eye protection when working with batteries.
- Remove all jewelry before performing electrical work.
- Install batteries in a well-ventilated area to help prevent the possible buildup of explosive gases.
- Do not mix battery types.
- Do not smoke in the vicinity of a battery.
- Use insulated tools when working with batteries.
- When connecting batteries, always verify proper voltage and polarity.
- Do not short-circuit the battery.
- Always use proper lifting techniques when handling batteries.

Failure to follow these instructions will result in death or serious injury.

For full installation instructions and safety information, see the documentation provided with the batteries. Consult the MSDS for the batteries for first aid procedures, emergency procedures, and clean-up instructions.

FCC Information to the User

This equipment has been tested and found to comply with the limits for a Class B digital device, pursuant to part 15 of the FCC Rules and Industry Canada ICES-003. These limits are designed to provide reasonable protection against harmful interference when the equipment is operated in a residential environment. This equipment generates, uses, and can radiate radio frequency energy and, if not installed and used in accordance with the installation and operation guides, may cause harmful radio frequency interference with radio communications. However, there is no guarantee that interference will not occur in a particular installation. If this equipment does cause harmful interference with radio or television reception, which can be determined by turning the equipment off and on, the user is encouraged to try to correct the interference by one or more of the following measures:

- Reorient or relocate the receiving antenna.
- Increase the separation between the equipment and the receiver.
- Connect the equipment to a different circuit from that to which the receiver is connected.
- Consult the dealer or an experienced radio or TV technician for help.

Contents

Important Safety Instructions-----vii

1 Introduction

Features -----	1-2
Charge Controlling -----	1-2

2 Installation

PV Array Requirements -----	2-2
Mounting -----	2-3
Choosing a Location -----	2-3
Removing the Wiring Compartment Cover -----	2-5
Removing Knockouts -----	2-6
Mounting the Unit -----	2-7
PV Grounding-----	2-8
Chassis Grounding -----	2-8
Internal Ground Fault Protection -----	2-8
Wiring -----	2-9
Connector Locations -----	2-9
Wire Size and Over-current Protection Requirements -----	2-10
PV Current Rating -----	2-10
Minimum Wire Gauge -----	2-10
Over-current Protection -----	2-11
Connecting the Unit -----	2-12
Connecting Multiple PV Array Strings to One Unit -----	2-13
Connecting Multiple Units -----	2-13
Auxiliary Output Connections-----	2-15
Network Installation-----	2-16
Network Components -----	2-17
Ordering Network Components -----	2-17
Network Layout -----	2-18
Connecting Network Cables Between Multiple Units -----	2-18
Installing the Battery Temperature Sensor-----	2-19
Commissioning-----	2-21
Setting the Device Number -----	2-21
Configuring Connections and Charger Settings -----	2-22
Copying a Unit's Settings to Another Unit -----	2-23
Starting the Unit -----	2-24

3 Troubleshooting

PV Charge Control Troubleshooting----- 3-2
Replacing the Ground Fault Protection Fuse----- 3-4
Ground Faults in a Normally Ungrounded Array ----- 3-5

A Specifications

Electrical Specifications ----- A-2
 MPPT Voltage Range ----- A-3
 Operating Below the PV Array Voltage Full Power Range ----- A-3
Default Battery Charger Settings ----- A-4
Mechanical Specifications ----- A-5
Recommended Accessories ----- A-5
Optional Accessories ----- A-6
Regulatory Approvals----- A-6

Index----- IX-1

1

Introduction

Chapter 1 describes features and functions of the Xantrex XW MPPT 80 600.

For information on:	See:
"Features"	page 1-2
"Charge Controlling"	page 1-2

Features

The Xantrex XW MPPT 80 600 is a photovoltaic charge controller that tracks the maximum power point of a PV array to deliver the maximum available current for optimum charging of batteries. The unit can be used with 24 and 48 VDC battery systems only.

The unit is designed to regulate the available power from a PV source only. It is not designed to regulate power from other types of power sources.

The unit can be installed (in single or multi-unit configurations) with a Xantrex XW Hybrid Inverter/Charger or as a stand alone battery charger. However, it is recommended that, at minimum, a Xantrex XW System Control Panel (Xantrex XW SCP) or Xantrex Gateway be included in the system (see “Optional Accessories” on page A-6 for product part numbers). The Xantrex XW SCP provides both status information and the ability to change settings, while the Xantrex Gateway (access via a personal computer) provides status only.

Charge Controlling

The unit can regulate PV array current at an appropriate level for 24 or 48 V batteries. It produces up to 80 amps of charging current for both battery voltages up to 2560 watts (24 V) or 4800 watts (48 V).

The unit controls how the batteries are charged by the DC source (the PV array). It can be configured to use a two-stage (no float) or three-stage charging process to maintain battery voltage at bulk, absorption, or float levels. When charging, the unit regulates the battery voltage and the output current based on the amount of DC power available from the PV array and the state of charge of the battery. See the Xantrex XW MPPT 80 600 Operation Guide for more information on two-stage and three-stage charging as well as the different stages.

2

Installation

Chapter 2 provides installation instructions for the Xantrex XW MPPT 80 600. Before installing the unit, read this entire chapter.

For information on:	See:
"PV Array Requirements"	page 2-2
"Mounting"	page 2-3
"PV Grounding"	page 2-8
"Wiring"	page 2-9
"Connecting Multiple PV Array Strings to One Unit"	page 2-13
"Connecting Multiple Units"	page 2-13
"Auxiliary Output Connections"	page 2-15
"Network Installation"	page 2-16
"Installing the Battery Temperature Sensor"	page 2-19
"Commissioning"	page 2-21

⚠ WARNING

HAZARD OF ELECTRIC SHOCK, BURNS, FIRE, AND EXPLOSION

Installation of this equipment should only be planned and performed by qualified personnel in accordance with all applicable installation codes. See “Audience” on page iii for the definition of qualified personnel.

Failure to follow these instructions can result in death or serious injury.

⚠ WARNING

**HAZARD OF ELECTRIC SHOCK, BURNS, FIRE, AND EXPLOSION
RISK OF EQUIPMENT DAMAGE**

Unsafe conditions and damage to the unit may result if the instructions and electrical, physical, and environmental installation specifications in this Guide are not obeyed.

Failure to follow these instructions can result in death or serious injury.

PV Array Requirements

Important: The following information only provides general guidelines. PV array installation is subject to installation codes and, in some areas, inspection and approval by the authority having jurisdiction. For example, installations in the USA must be compliant with NFPA 70 and in particular Article 690.

Each unit must be connected to its own PV array. Up to three PV array strings can be paralleled. See “Connecting Multiple PV Array Strings to One Unit” on page 2–13.

A design guide is available to assist with choosing an optimal PV array size.

1. Go to www.schneider-electric.com.
2. Open the **Products and Services** tab and click **Renewable Energies**.
3. Navigate to your specific product page.
4. Click **Sizing Tools**.

⚠ WARNING

HAZARD OF SHOCK

The PV array voltage must never exceed 600 VOC (open circuit voltage) under any conditions. The PV array I_{sc} (short circuit current) must not exceed 28 A at STC (based on array nameplate ratings) or 35 ADC absolute maximum under any conditions.

Failure to follow these instructions can result in death or serious injury.

PV panel strings configured to provide current no more than 28 A at STC are required to allow for increases in I_{sc} caused by irradiance enhancement under certain conditions (light reflection from snow, for example).

Mounting

The instructions in this chapter are applicable to a typical stand-alone installation. Installation procedures will vary according to your specific application. For special applications, consult a qualified Renewable Energy System installer or a Certified Dealer. If installing the unit as part of a Xantrex XW System, see the *Xantrex XW Power System Installation Guide* for additional information (Document Part Number 975-0239-01-01).

Choosing a Location

⚠ WARNING

HAZARD OF ELECTRIC SHOCK, BURN, FIRE, AND EXPLOSION RISK OF EQUIPMENT DAMAGE

The unit must be mounted vertically and installed indoors in a dry, protected location away from flammable materials, sources of high temperature, moisture, and vibration. The location must also be sheltered from direct sunlight, dust, and wind-blown debris.

Failure to follow these instructions can result in death or serious injury.

⚠ WARNING

HAZARD OF EXPLOSION

Do not install in a sealed compartment containing batteries.

Failure to follow these instructions can result in death or serious injury.

For optimal and safe operation, make sure there is adequate clearance around the unit. See Table 2-1 and Figure 2-1. If clearances are reduced below these minimums, charging performance may be impaired.

Table 2-1 Minimum Clearance Requirements

Location	Minimum Clearance
Above and below	6 inches (150 mm). Do not mount units in a vertical stack. Note: One unit can be mounted on the side of the Xantrex XW Power Distribution Panel ^a (part number 865-1015). For more information, see the <i>Xantrex XW Power System Installation Guide</i> , available with the Xantrex XW Hybrid Inverter/Charger. Other installations must follow the guidelines in this Guide.
In front	Sufficient room to allow for easy access to see the LEDs and to perform maintenance.
Sides	No clearance requirement.

a. The Xantrex XW Power Distribution Panel is not available outside North America.

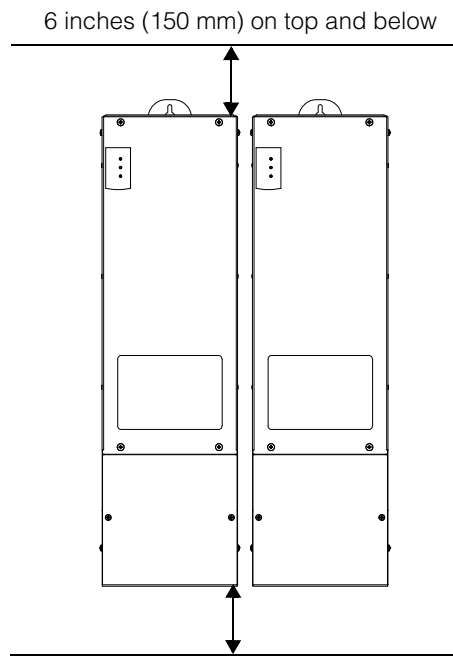

Figure 2-1 Minimum Clearance Requirements

Removing the Wiring Compartment Cover

⚠ DANGER

HAZARD OF ELECTRIC SHOCK AND ENERGY

Before removing the wiring compartment cover, make sure all sources of electricity have been disconnected for at least 2 minutes. Before energizing the unit, make sure the wiring compartment cover has been replaced with all fasteners.

Failure to follow these instructions will result in death or serious injury.

Before mounting, remove the wiring compartment cover to access the mounting holes and the wiring terminals. The wiring compartment cover is secured with two screws on the front of the unit. See Figure 2-2.

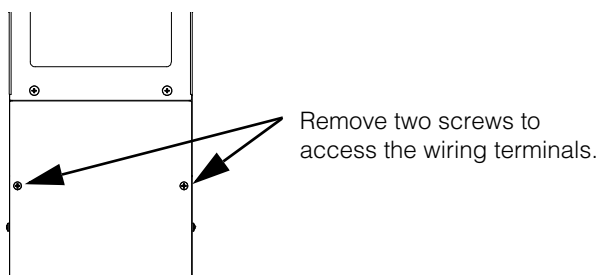

Figure 2-2 Removing the Wiring Compartment Cover

The wiring compartment (Figure 2-3) contains a flexible Lexan™ barrier used to segregate battery and PV wire routing. In some instances, you must manipulate this barrier to provide a passage for battery or PV cables running through the wiring compartment. In this scenario, you must take care to avoid intermingling of PV and battery wires.

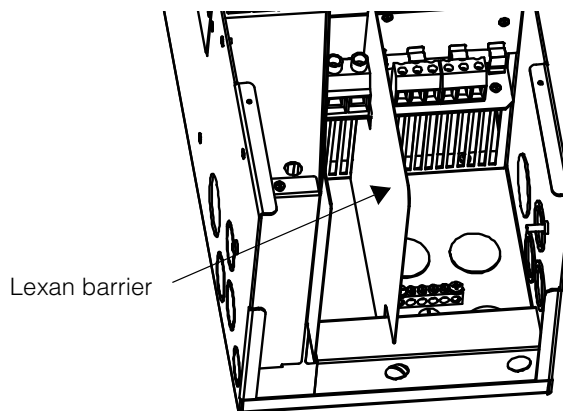

Figure 2-3 Wiring Compartment with Lexan Barrier

Removing Knockouts

Fourteen knockouts are provided for conduit or cable entry into the unit (see Figure 2-4 and Figure 2-5):

- Three single (one on each side and one on the back) for battery wires (44.0 mm).
- Two single on the back and six dual on the sides (three on each side) for PV array wires (35.0 mm).
- Three dual (one on each side and one on the back) for routing BTS and network cables (28.2 mm).

When removing knockouts, make sure no metal shavings or fragments fall into the wiring compartment. Use bushings or conduits to help protect the wiring from damage from rough edges around the knockout holes.

CAUTION
RISK OF EQUIPMENT DAMAGE
Do not drill, cut, or punch holes in the unit. Use only the knockouts provided for conduit entry.
Failure to follow these instructions can result in equipment damage.

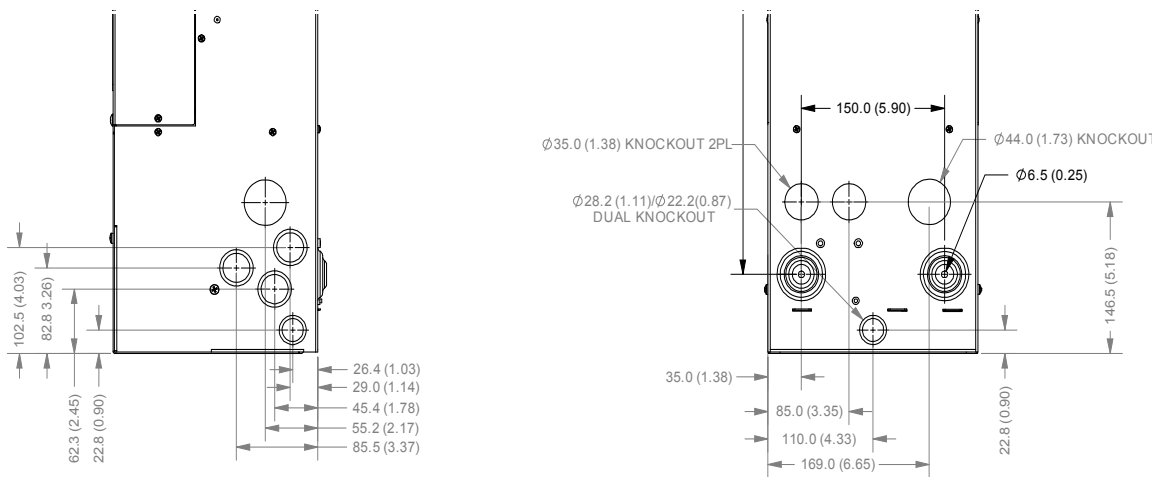
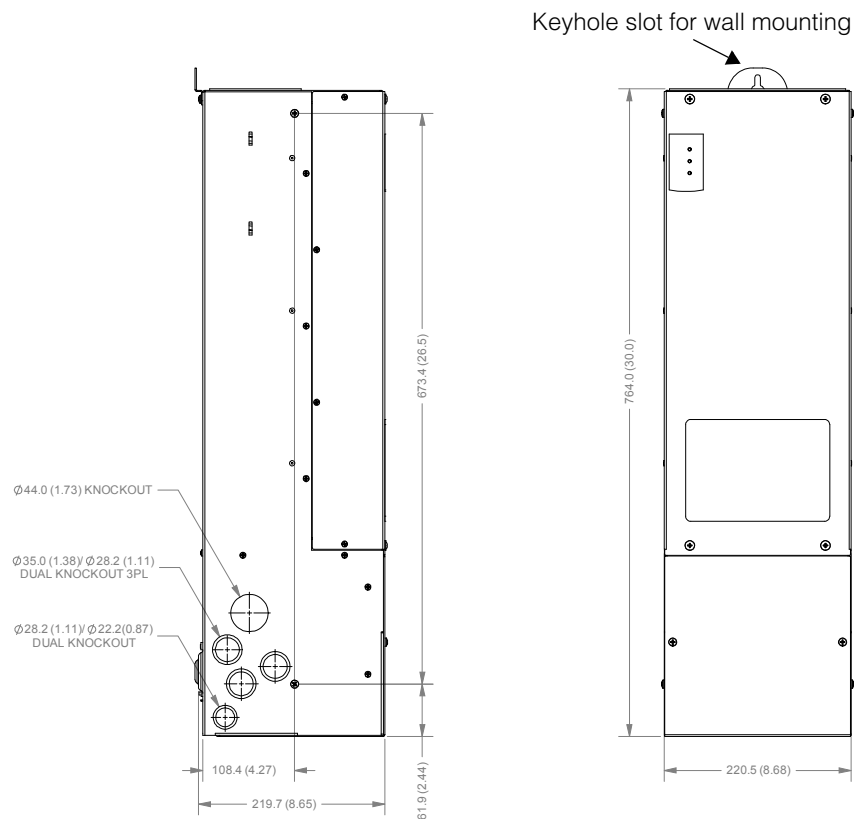

Figure 2-4 Knockout Dimensions



All measurements in mm (in.)

Figure 2-5 Dimensions and Knockout Locations

Mounting the Unit

The unit must be vertically mounted to the wall using three ¼-inch × ½-inch (6.35 mm × 12.5 mm) pan-head screws. It can also be mounted on the side of the Xantrex XW Power Distribution Panel (hardware provided with the unit). For more information, see the *Xantrex XW Power System Installation Guide*.

To mount the unit (see Figure 2-6):

1. Remove the wiring compartment cover (see page 2–5).
2. Mark the location of the keyhole slot on the wall.
3. Secure the top mounting screw in the location marked. Leave the screw head backed out approximately ¼ inch (6 mm).
4. Place the controller onto the screw and pull it down into the keyhole slot.
5. Insert two screws in the two mounting holes provided to secure the unit to the wall.

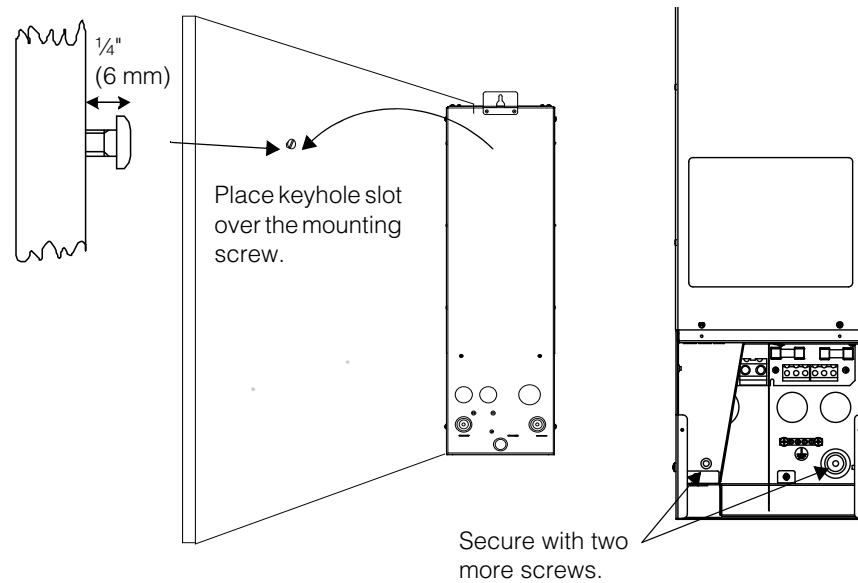

Figure 2-6 Mounting the Unit

PV Grounding

The unit can be configured to be compatible with either negative-grounded, positive-grounded, or ungrounded (floating) PV systems. For information about routing the ground connection, see Figure 2-9 on page 2-14.

Chassis Grounding

The recommended size of the chassis ground conductor is #8 AWG (8.5 mm²)¹. For ground conductor requirements for your specific installation, consult your local electrical code.

Internal Ground Fault Protection

The unit has two types of ground fault protection. For grounded arrays, the unit has two PV ground fault protection fuse holders (for use with fuses rated 600 VDC, 1 A maximum) located inside the wiring compartment. The fuse provides both a ground bond and ground fault protection for grounded PV array systems. For ungrounded arrays, the unit detects the resistance between the array and ground, and it indicates a fault if the resistance is too low. The unit is configured at the factory for an ungrounded PV array connection. For both types of ground fault protection, if the unit determines that a ground fault has occurred, it will cease operating and will indicate a fault on the unit's display and over the Xantrex Xanbus™ network (if used).

¹.Based on the NEC (NFPA 70) Article 250 for 100 A maximum battery fuse.

⚠ WARNING**HAZARD OF ELECTRIC SHOCK AND FIRE****Grounded PV system:**

Install a fuse in the correct holder (+) or (-). Do not ground either PV conductor outside of the unit. Replace fuse with same type and rating.

Ungrounded (floating) PV system:

Leave both fuse holders empty. Do not ground either PV conductor outside of the unit.

Fuses must only be replaced by qualified service personnel.

Failure to follow these instructions can result in death or serious injury.

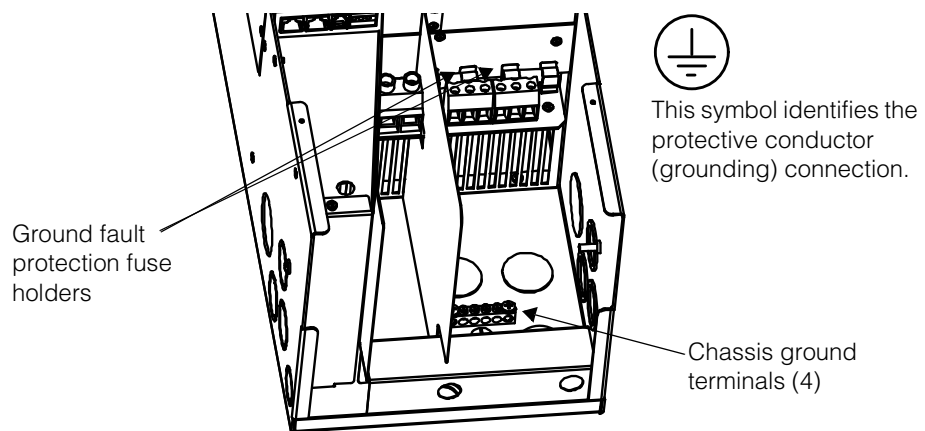

Figure 2-7 Chassis Ground Connector

Wiring

The following sections provide information about wiring.

Connector Locations

Terminal connectors for DC wiring are located inside the wiring compartment. The labels above the DC wiring terminals identify all the connection points. See Figure 2-8.

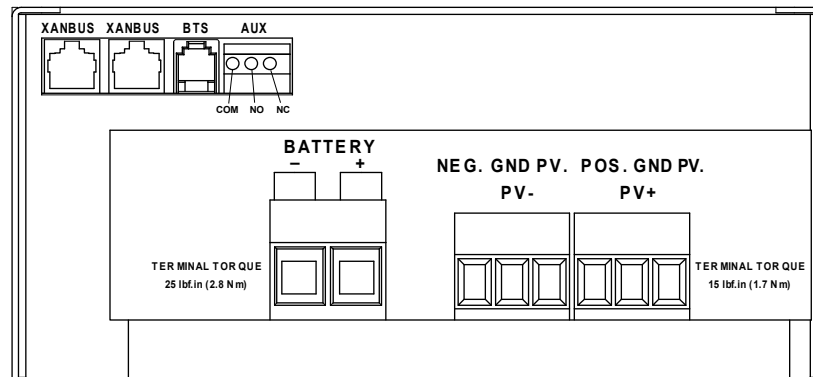

Figure 2-8 DC Terminal Connector Locations

A label providing details on each connector and torque requirements for each terminal is affixed to the inside of the wiring compartment cover plate.

Wire Size and Over-current Protection Requirements

⚠ WARNING
<p>HAZARD OF ELECTRIC SHOCK, ENERGY, AND FIRE</p> <p>The wiring, over-current protection devices (fuses and circuit breakers), and installation methods used must conform to all national and local electrical code requirements. Wiring must be protected from physical damage with appropriate methods such as the use of conduit and strain relief clamps.</p> <p>To prevent intermingling with hazardous voltage-level wiring, the BTS, auxiliary output, and network cables must pass through a different conduit than the PV and battery cables.</p> <p>Failure to follow these instructions can result in death or serious injury.</p>

PV Current Rating

The PV input of the unit is electronically limited to 23 A under all conditions of operation. The gauge of PV wiring must coordinate with local electrical code requirements and the total array short circuit current, based on the published I_{SC} rating of the PV panels installed in the system.

Minimum Wire Gauge

For installations where the PV array output short-circuit rating is the maximum allowable (28 A at STC), the recommended smallest wire size is #8 AWG (10 mm²)¹ copper wire with a 75 °C (167 °F) insulation rating. The wire gauge requirements vary with those of the local jurisdiction. For details, consult the electrical code.

¹.Based on NEC Table 310-16.

Over-current Protection

⚠ WARNING

HAZARD OF ELECTRIC SHOCK, ENERGY, AND FIRE

Over-current protection must be provided, external to the unit, to protect the PV and battery wiring. External disconnecting means must also be provided for the PV and battery circuits. Consult local electrical codes to establish the correct fuse or circuit breaker ratings and for required locations of protection and disconnecting means.

Failure to follow these instructions can result in death or serious injury.

If a fuse is used for over-current protection, a disconnect switch must also be provided between the fuse and the source of supply (the PV array or the battery). If a circuit breaker is used, it will serve both purposes of disconnection and over-current protection.

Battery Circuit

For installations in the USA, the NEC requires that the battery circuit be protected with a device rated for 125% of the rating of the circuit. The DC-rated fuse or circuit breaker between the battery and the unit must be rated, at minimum, 100 A and must not exceed the allowable over-current protection rating for the size of wire being used, in accordance with applicable electrical codes.

PV Circuit

A properly rated PV disconnect switch is mandatory between the PV array and the unit, and it must be rated for 600 VDC and have a sufficient current rating for your specific installation.

⚠ DANGER

HAZARD OF ELECTRIC SHOCK

The PV disconnect switch can only be installed safely if the array is covered with an opaque (dark) material.

Failure to follow these instructions will result in death or serious injury.

For installations with three or more PV array strings connected to one unit, each string must be fused before being combined at the PV input terminal connector inside the wiring compartment. See “Connecting Multiple PV Array Strings to One Unit” on page 2–13 for more information.

You can use separate disconnect switches for each PV string and combine these in the unit, as long as the following conditions are met:

- Each PV string is fused.
- All disconnects are placed side by side, so that it is clear that all need to be thrown for a complete and visible PV disconnect.

Connecting the Unit

The following procedure is illustrated in Figure 2-9 on page 2-14.

⚠ DANGER
HAZARD OF ELECTRIC SHOCK Whenever a PV array is exposed to light, a shock hazard exists at the output wires or exposed terminals. Open the array disconnect switch before making the connections. Failure to follow these instructions will result in death or serious injury.

To connect the unit in a negative-grounded system:

1. Make sure the PV array disconnect and battery disconnect are turned off.
2. Install a cable clamp in each knockout being used.

CAUTION
RISK OF REVERSE POLARITY DAMAGE Before energizing the unit from either the PV array or from the battery, check the polarity of all power connections. Positive (+) must be connected to positive (+). Negative (-) must be connected to negative (-). Failure to follow these instructions can result in equipment damage.

3. Ground the unit. Connect a grounding conductor between a unit ground lug and the grounding electrode (as shown in Figure 2-9).
4. Connect the PV array's negative (-) output to the unit terminal marked PV -.
5. Connect the PV array's positive (+) output to the PV array disconnect.
6. Route another positive (+) cable from the other end of the PV disconnect to the unit terminal marked PV +.
7. Connect the negative (-) battery cable to the unit terminal marked BAT -.
8. Connect a positive (+) cable from the unit terminal marked BAT + to the battery disconnect.
9. Connect a second positive (+) cable to the other side of the battery disconnect and connect to the positive (+) battery terminal.
10. Torque the unit's battery terminals to 25 lbf.in (2.8 Nm) and the PV terminals to 15 lbf.in (1.7 Nm). Allow some slack on the cables within the unit and secure the wiring with strain reliefs or cable clamps.

To connect the unit in a positive-grounded or floating system:

- ◆ Follow the same steps as above for a negative-grounded unit, except note the location of the disconnect switch will vary as follows:
 - For positive-grounded systems, the disconnect switch must be in the negative conductor.
 - For floating systems, the disconnect switch must be a 2-pole type connected in both the positive and negative conductors.

In general, the same rules apply for disconnect switches as for battery circuits: they must be located in all ungrounded conductors. Requirements vary so consult local code.

Connecting Multiple PV Array Strings to One Unit

The unit has two three-pole connectors, allowing up to three PV array strings to be combined in the unit. Input connectors can accept #6 to #14 AWG (13.5 to 2.5 mm²) solid or stranded wire.

▲ WARNING

HAZARD OF FIRE

Fuses are required when paralleling (combining) more than two PV strings. Fuses must be installed in a combiner or in a PV disconnect safety switch. These items are not provided with the unit.

Failure to follow these instructions can result in death or serious injury.

Connecting Multiple Units

In a multiple-unit installation, each unit must be connected to a separate PV array. See Figure 2-10. For other multiple-unit installation considerations, see “Network Installation” on page 2-16.

CAUTION

RISK OF EQUIPMENT DAMAGE

Make sure that each unit is correctly connected to its own PV array(s) and that no wires are interconnected between charge controllers.

Failure to follow these instructions can result in equipment damage.

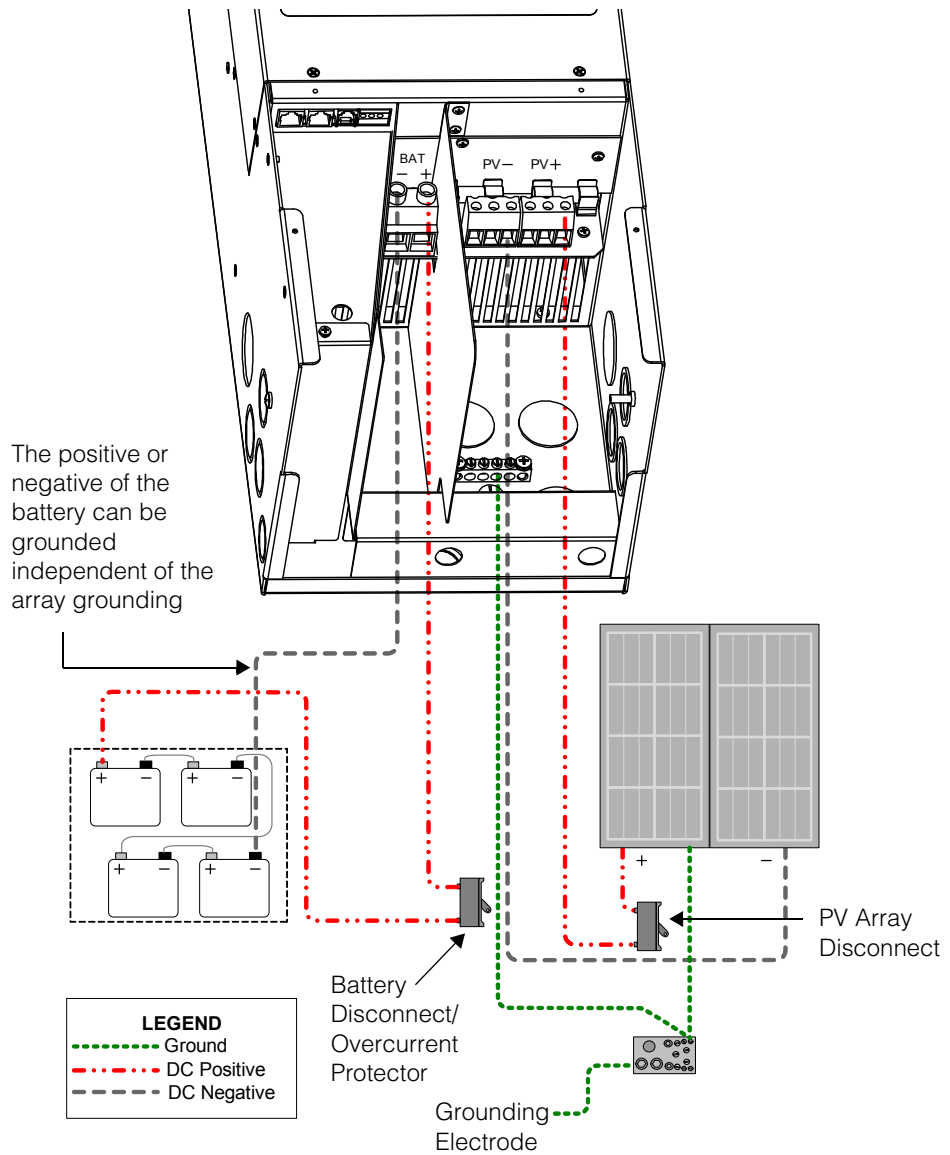

Note that grounding and disconnect locations may vary according to system design and local electrical codes.

Figure 2-9 Wiring (48 V Battery Bank Shown)

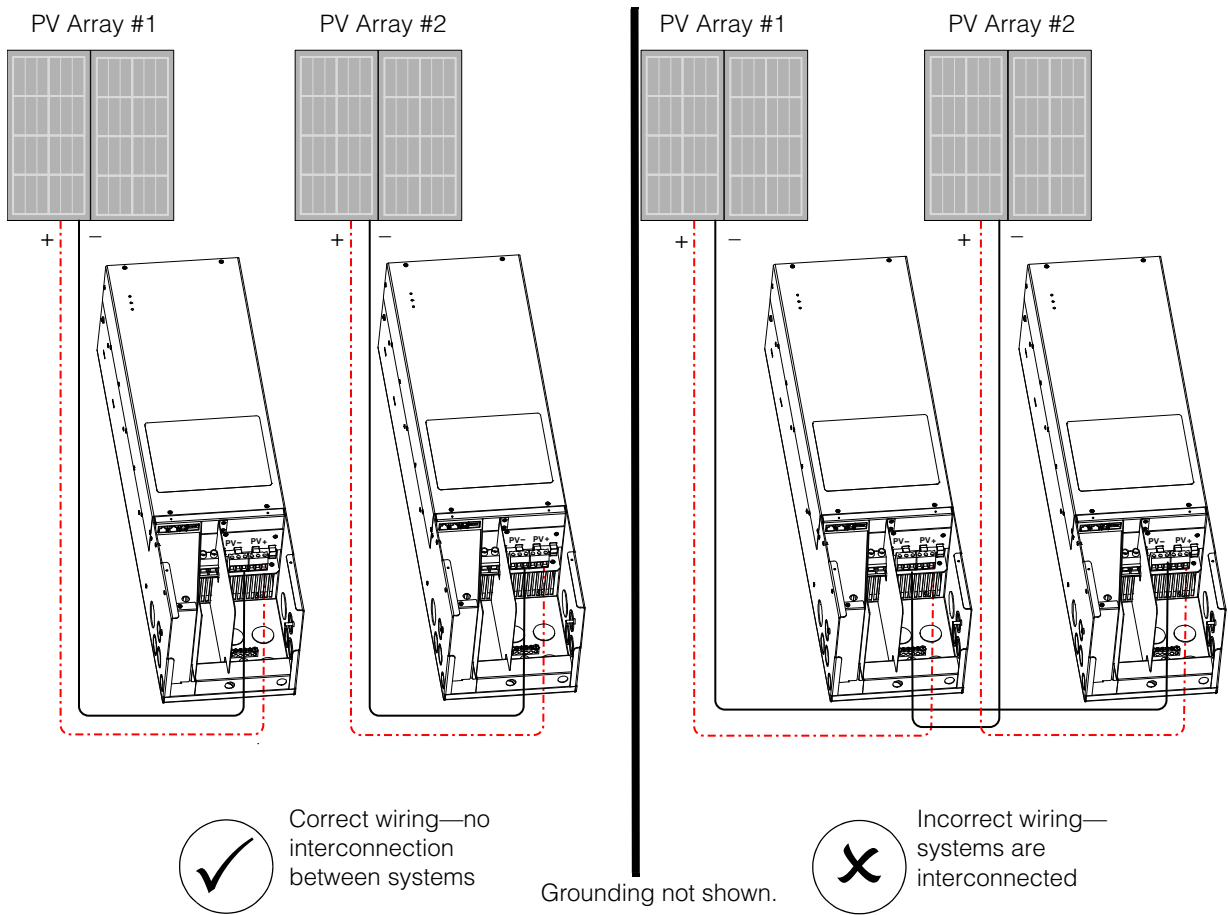

Figure 2-10 Multiple Unit DC Wiring

Auxiliary Output Connections

The auxiliary output (dry relay contacts) provides a connector which can accept wire sized from #22 to #14 AWG (0.5 to 2.5 mm²), copper solid or stranded. As shown in Figure 2-11, the auxiliary output can control 12 VDC power to a fan to vent the battery compartment. For this application, the unit’s auxiliary output must be configured to activate when the batteries reach a pre-set voltage level. See “Configuring the Auxiliary Output” in the operation guide.

⚠ WARNING

HAZARD OF FIRE

The auxiliary NO and NC dry contacts are rated up to 60 VDC and up to 8 A. Do not expose the auxiliary contacts to voltages or currents higher than this rating. Provide external over-current protection rated 8 A maximum.

Failure to follow these instructions can result in death or serious injury.

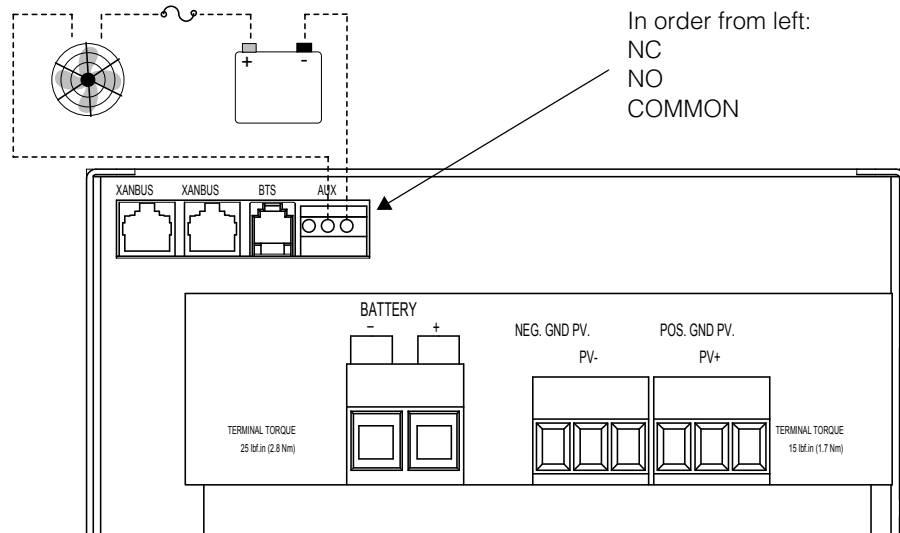

Figure 2-11 Auxiliary Output Vent Fan Application

Network Installation

The unit is a Xantrex Xanbus-enabled device. Xantrex Xanbus is a network communications protocol. The unit is able to communicate its settings and status to other Xantrex Xanbus-enabled devices, such as Xantrex XW Hybrid Inverter/Chargers, the Xantrex XW System Control Panel (Xantrex XW SCP), the Xantrex XW Automatic Generator Start, the Xantrex XW Solar Charge Controller, and other Xantrex XW Charge Controllers.

Xantrex Xanbus connections between multiple units allows information about each unit and its associated PV array to be communicated among all of the units in the system. Information about the entire system can be viewed on the Xantrex XW SCP.

For example, in a two-unit system, if unit #1 is producing 1500 W and unit #2 is producing 2000 W, the Xantrex XW SCP displays a total system power of 3500 W. The accumulated amp hours and kilowatt hours produced by each unit for that day is also displayed.

Networked units also share battery temperature information if a single BTS is connected to a single unit (or Xantrex XW Hybrid Inverter/Charger) in the system.

Network Components

A Xantrex Xanbus network consists of the following components:

- Xantrex Xanbus-enabled devices: These include the unit, the Xantrex XW Hybrid Inverter/Charger, Xantrex XW Automatic Generator Start, and Xantrex XW SCP. The network can consist of up to three Xantrex XW Hybrid Inverter/Chargers, two units, one Xantrex XW Automatic Generator Start, and one Xantrex XW SCP. When only units are installed, up to ten can be networked together.
- Xantrex Xanbus power supply: The unit provides up to 7 W of power on the Xantrex Xanbus network to power one Xantrex XW SCP, one Xantrex XW Automatic Generator Start, and one Xantrex Gateway, not including the auxiliary supply. To reduce tare losses at night, you can configure the unit to shut off the Xantrex Xanbus power supply after sunset if you do not need device status information when it is not operating. See “Disabling Power Supplies at Night” in the Xantrex XW MPPT 80 600 Operation Guide for more information.
- Network cables: Each Xantrex Xanbus-enabled device is connected by a standard Ethernet (CAT 5 / CAT 5e) patch cable. Do not use crossover cable.
- Network terminators (Figure 2-12): The Xantrex Xanbus network must be properly terminated at each end to ensure communication signal quality on the network. Network terminators plug into network ports on Xantrex Xanbus-enabled devices. The unit and other Xantrex Xanbus-enabled devices ship with one terminator. Depending on your network layout, this terminator may need to be inserted into another device elsewhere in the network. One terminator is required for all Xantrex Xanbus network configurations.

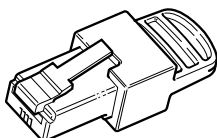

Figure 2-12 Network Terminator

Ordering Network Components

Table 2-2 provides a partial list of network components and part numbers. Cables are available in standard lengths from 3 feet (0.9 m) to 75 feet (22 m). Call your dealer or visit www.schneider-electric.com to purchase cables and other network components.

Table 2-2 Network Components and Part Numbers

Network Component	Part Number
Network terminators	Available on request
Network terminator (male) 2-pack	809-0901
Network terminator (female) 2-pack	809-0905
Network connector	809-0903

Network Layout

Xantrex Xanbus-enabled devices are connected with separate lengths of cable. The devices at each end of the chain must have a terminator inserted into their open network ports, as shown in Figure 2-13. Total cable length for the Xantrex Xanbus network must not exceed 131 feet (40 m).

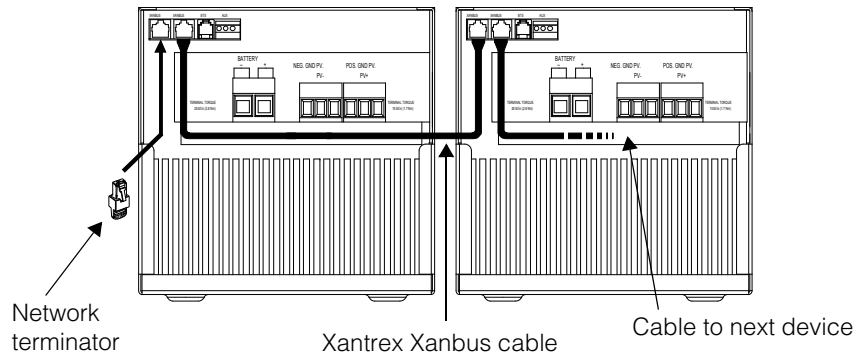

Figure 2-13 Network Layout

Connecting Network Cables Between Multiple Units

⚠ WARNING

HAZARD OF ELECTRIC SHOCK

Do not route the network cables in the same conduit or panel as the PV or battery input/output cables, and make sure the network cables are not mingled with conductors from those systems.

Failure to follow these instructions can result in death or serious injury.

Dual knockouts on the back and sides of the unit are provided for routing the Xantrex Xanbus network cable (see Figure 2-4 on page 2-6). See Figure 2-8 on page 2-10 for the location of the unit's Xantrex Xanbus ports.

Important: Connect only Xantrex Xanbus-enabled devices. Although the cabling and connectors used in this network system are the same as ethernet connectors, **this network is not an ethernet system.**

Important: Do not connect one end of the network to the other to make a ring or loop.

To connect network cables between multiple units:

1. Remove the wiring compartment cover from each unit (see "Removing the Wiring Compartment Cover" on page 2-5).
2. Remove a knockout from the back or either side of the unit, and then install an appropriately sized strain relief bushing for the network cable.

3. Connect the network cable to a Xantrex Xanbus port in unit #1.
4. Route the cable to unit #2.
5. Connect the network cable to a Xantrex Xanbus port in unit #2.
6. Connect another network cable to unit #2 and route the cable to the next device in the network.
7. Make sure the factory-supplied network terminators are inserted into the empty Xantrex Xanbus ports in the devices at the beginning and end of the network. There should be no empty Xantrex Xanbus ports in any of the units.

Installing the Battery Temperature Sensor

Installing a Battery Temperature Sensor (BTS) is recommended for optimum charging performance and battery life extension. If a BTS is not installed and the batteries will operate in hot or cold conditions, manually adjust the temperature settings to suit the conditions. See “Configuring Battery Characteristics and Battery Charging” in the Xantrex XW MPPT 80 600 Operation Guide.

Only one BTS is required per battery bank if multiple units or a complete Xantrex XW Power System with Xantrex XW Hybrid Inverter/Chargers are networked together using Xantrex Xanbus. All networked Xantrex XW Series devices share battery temperature information, and the BTS can be connected to a unit or a Xantrex XW Hybrid Inverter/Charger. If more than one BTS is used within the system, the highest reported temperature from all of the units with an attached BTS will be used as the battery temperature for the temperature compensation value of the battery charge algorithm.

See Figure 2-8 on page 2–10 for the location of the unit’s BTS port. Dual knockouts on the back and sides of the unit are provided for routing the BTS cable (see Figure 2-4 on page 2–6).

Important: If the sensor cable is damaged and the wires are shorted, the unit registers a battery over temperature fault condition. If the BTS wires have been cut, the unit assumes that the BTS is not connected. A replacement BTS can be ordered from the manufacturer (part number 808-0232-02).

To install the BTS:

1. Remove the unit’s wiring compartment cover (see “Removing the Wiring Compartment Cover” on page 2–5).
2. Remove a knockout from the back or either side of the unit, and then install an appropriately sized strain relief bushing for the BTS cable.
3. Connect the ring terminal on the BTS directly to the negative battery terminal or positive battery terminal, or use the adhesive backing on the sensor back to attach the sensor to any side of the battery to be monitored. See Figure 2-14.

If connecting to the battery terminal, make sure the BTS does not prevent the power wiring from making the best possible contact with the battery terminal. If using the adhesive backing, install the BTS on the side of the battery below

the electrolyte level. It is best to place the sensor between batteries and place the batteries in an insulated box to reduce the influence of the ambient temperature outside the battery enclosure.

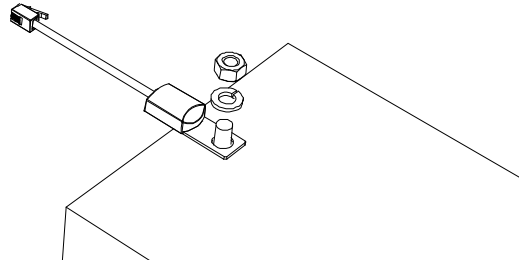

Figure 2-14 Attaching the BTS to a Battery Terminal

⚠ WARNING

HAZARD OF SHOCK

The BTS cable must not pass through the same conduit used for PV wiring and battery cables.

Failure to follow these instructions can result in death or serious injury.

4. Pass the other end of the BTS cable through the knockout and strain relief bushing on the unit and insert the BTS plug into the BTS RJ-11 port. See Figure 2-15.
5. Replace the unit's wiring compartment cover.

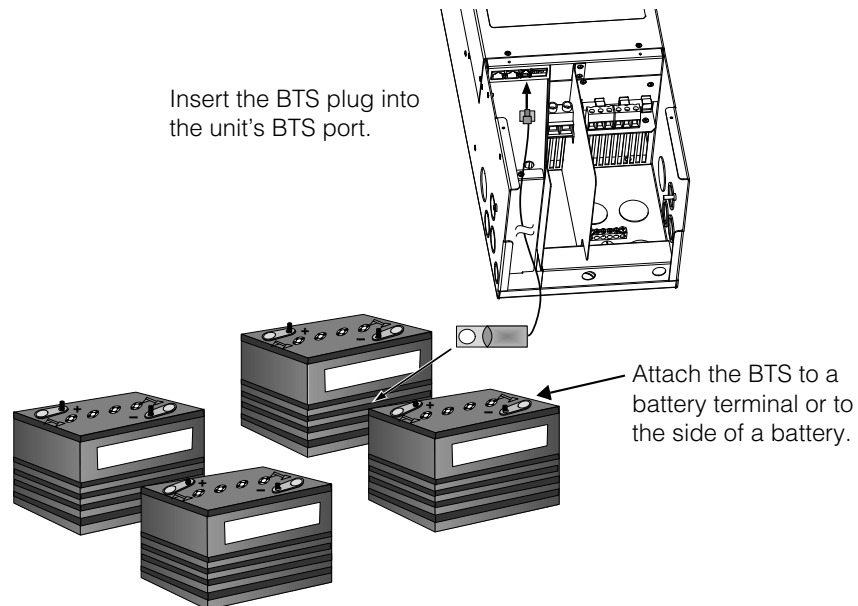

Figure 2-15 Installing the BTS

Commissioning

Use the Xantrex XW SCP to commission a unit. For information about Xantrex XW SCP navigation and menus, see the appendix, “Xantrex XW System Control Panel Menus” in the Xantrex XW MPPT 80 600 Operation Guide. Before you begin, make sure you have important system information such as the nominal battery voltage, battery type, and battery bank capacity available.

If you are commissioning one unit, follow these two procedures:

1. “Setting the Device Number” on page 2–21
2. “Configuring Connections and Charger Settings” on page 2–22
3. “Starting the Unit” on page 2–24

If you are commissioning multiple units, follow these three procedures:

1. “Setting the Device Number” on page 2–21
2. “Configuring Connections and Charger Settings” on page 2–22
3. “Copying a Unit’s Settings to Another Unit” on page 2–23
4. “Starting the Unit” on page 2–24

When commissioning multiple units on the same Xantrex Xanbus network, make sure to set a unique device number and the correct battery connection for each unit. The connection is important to define so that system totals and other related information are displayed accurately.

Setting the Device Number

To set a device number for the unit:

1. Make sure a Xantrex XW SCP is attached to the unit’s Xantrex Xanbus network.
2. Close the DC disconnect (or use a selector switch to apply battery power to all units at the same time if commissioning multiple units). When a unit is powered up, it will detect that a Xantrex XW SCP is already operating on the network and be ready for configuration through the Xantrex XW SCP. Do not apply PV power at this point.
3. On the Xantrex XW SCP’s *System Status* home screen, press Enter.
The *Select Device* menu opens.
4. Use the arrow buttons to scroll to the unit to configure, and then press Enter. Each unit appears as *XW MPPT80 xx*, where *xx* is its device number.
The *Setup* menu opens.
5. To display the *Advanced Settings* menu item press the Enter, up arrow, and down arrow buttons simultaneously.



6. Press Enter to select `Advanced Settings`.
The `Config` menu opens.
7. Scroll to `Multi Unit Config`, and then press Enter.
The `Multi` menu opens. The three LEDs on the unit you are configuring will start to flash when you enter this menu, providing visual confirmation of the unit you are configuring.
8. Scroll to `Dev Number`, and then press Enter. Scroll to set it to a number other than 00. Press Enter to confirm the new device number.
The device number can be set to any number between 01 and 31. If you are commissioning multiple units, the manufacturer recommends using 01 for the first unit.
9. Press Exit until the `Select Device` menu is displayed.
The unit appears as `XW MPPT80 xx` on the menu, where `xx` is the device number you selected.
10. Repeat steps 3 through 9 if you are commissioning multiple units.

Configuring Connections and Charger Settings

⚠ WARNING
HAZARD OF FIRE AND EXPLOSION Battery charging settings must be configured by qualified personnel in accordance with the battery manufacturer's recommended charging instructions. This section covers basic default settings. See the Xantrex XW MPPT 80 600 Operation Guide for additional configuration information and details including setting descriptions and value ranges. Failure to follow these instructions can result in death or serious injury.

To configure connections and charger settings for a unit:

1. On the `Select Device` menu, select `XW MPPT80 xx`, where `xx` is the device number.
The `Setup` menu opens.
2. Press Enter to select `Advanced Settings`.
The `Config` menu opens.
3. Scroll to `Multi Unit Config`, and then press Enter.
The `Multi` menu opens.
4. Scroll to `Connections`, and then press Enter.
The `Conn` menu opens.

5. Configure PV input (PV In) and DC output or the battery bank (DC Conn). If the system only has one battery bank, leave DC Conn at the default setting. The PV In setting allows you to differentiate which array is going to which unit. This setting is used for status reporting only, not for any internal controls. Setting PV In to a non-default value is optional.
6. Press Exit until the Config menu is displayed.
7. Scroll to Charger Settings, and then press Enter.
The Chgr menu opens.
8. Set the battery type (Batt Type), battery capacity (Batt Capacity), and any other charger settings required for your system. If you select Custom for the battery type, you can further configure bulk, absorption, float and other settings for the charge cycle in the Custom Settings menu that appears.
9. While in the Chgr menu, make sure the nominal battery voltage (Batt Voltage) is set correctly. The default value is 48 V. If your system is a 24 V battery system, then change it to 24 V.
10. Press Exit until the Select Device menu is displayed.

Copying a Unit's Settings to Another Unit

⚠ WARNING

HAZARD OF FIRE AND EXPLOSION

Do not copy settings from one unit to another unless the battery banks are identical – same size, type, and so on.

See the Xantrex XW MPPT 80 600 Operation Guide for additional configuration information and details including setting descriptions and value ranges.

Failure to follow these instructions will result in death or serious injury.

Settings that are copied from one unit to another are:

- Batt Type
- Batt Capacity
- Max Chg Rate
- Charge Cycle
- ReCharge Volts
- Absorb Time
- Default Batt Temp
- Batt Voltage
- DC Conn
- Custom battery settings (if Custom battery type selected) including Eqlz Support, Eqlz Voltage, Bulk Voltage, Absorb Voltage, Float Voltage, and BattTempComp.

If you are commissioning multiple units, copy the settings from the first unit configured to other units following these steps:

1. On the `Select Device` menu, select the next unit for configuration.
The `Setup` menu opens.
2. Press `Enter` to select `Advanced Settings`.
The `Config` menu opens.
3. Scroll to `Copy from`, and then press `Enter` to select the unit you want to copy from. Select the unit with the device number that matches the first unit you configured, and then press `Enter` again.
The settings are automatically copied from the selected unit.

Important: The `Copy from` command will not give you any indication that it has completed its task. To check that the charger settings have been copied properly, view some of the settings you originally configured.

4. Repeat steps 1 to 3 for the remaining units.
5. After you have finished configuring, press the `Enter`, `up arrow`, and `down arrow` buttons simultaneously to hide the `Advanced Settings` menu item.

Starting the Unit

To start the unit or units:

- ◆ Close the PV disconnect switch.

The unit or units start up and wait for a short period to determine that the input voltage is greater than the minimum operating voltage. After the input voltage exceeds the minimum operating voltage, the units begin operating.

3

Troubleshooting

Chapter 3 contains information about identifying and resolving possible problems that may arise while using a Xantrex XW MPPT 80 600.

PV Charge Control Troubleshooting

⚠ DANGER

HAZARD OF ELECTRIC SHOCK, BURNS, FIRE, AND EXPLOSION

This chapter includes hazardous tasks to be performed only by qualified personnel equipped with appropriate personal protective equipment and following safe electrical work practices. Review the “Important Safety Instructions” beginning on page vii before proceeding.

Failure to follow these instructions will result in death or serious injury.

Table 3-1 lists possible problems that may arise with the unit.

Table 3-1 PV Charge Control Problems

Problem	Possible Cause	Solution
Uneven output current between multiple units.	<p>A. Solar arrays are supplying different amounts of current to each unit.</p> <p>B. Charging set points are not all set the same.</p> <p>C. Excess voltage drop in wiring causing controllers to measure the battery voltage differently and regulate accordingly.</p> <p>D. Chargers are in constant voltage (absorption) mode and therefore are limiting their output current to maintain the present battery voltage. In this situation, some units will produce more output current than others.</p>	<p>A. Check array output, but consider that this could be a normal operating condition if the arrays are located in different locations and/or point in different directions.</p> <p>B. Set controllers to the same settings.</p> <p>C. Check wiring. Upgrading or shortening the wire run may be required.</p> <p>D. No need for intervention as this is a normal operating condition.</p>
The Xantrex XW SCP LCD shows a ground fault and the unit has stopped operating.	A ground fault has caused the ground fault protection fuse to blow, or a normally ungrounded array contains a ground fault.	See “Replacing the Ground Fault Protection Fuse” on page 3–4 or “Ground Faults in a Normally Ungrounded Array” on page 3–5.
The unit’s Error/Warning (red) LED is on or flashing.	An active fault, error, or warning is present on the unit.	See “Viewing Active Faults, Errors, and Warnings” in the Xantrex XW MPPT 80 600 Operation Guide to determine which alarm is active on the unit. The tables in this section provide detailed information on why various alarms could be occurring on the unit.

Table 3-1 PV Charge Control Problems

Problem	Possible Cause	Solution
The unit's Error/Warning (red) LED is on, and the Xantrex XW SCP indicates a ground fault (F56) for the unit.	A ground fault has caused the ground fault protection fuse to blow, or a normally ungrounded array contains a ground fault.	See "Replacing the Ground Fault Protection Fuse" on page 3–4 or "Ground Faults in a Normally Ungrounded Array" on page 3–5.
The unit's Error/Warning (red) LED is on, and the Xantrex XW SCP indicates an output under voltage error (F11) for the unit.	A. The default configuration for the unit is a 48 V battery bank, and you have installed the unit on a 24 V battery bank. B. The batteries you have installed are dead or undercharged.	A. Use the Xantrex XW SCP to configure the unit for 24 V operation. See "Configuring Battery Characteristics and Battery Charging" in the Xantrex XW MPPT 80 600 Operation Guide for more information. B. Check the battery voltage to see if the batteries are within operating specifications. If necessary, replace them with new batteries, or use a device capable of performing dead battery charging.
The unit does not show up on the Xantrex XW SCP or it drops off the network periodically.	A. Network terminators have not been installed at both ends of the Xantrex Xanbus network. B. The total network length exceeds the maximum length specification.	A. Install a terminator at each far end of the network. See "Network Components" on page 2–17 for more information. B. See "Network Layout" on page 2–18 for more information.
The unit does not produce any power.	A. No PV input voltage. B. PV input voltage is not within operating range.	A. Change the PV disconnect switch from the off position to the on position. B. Make sure that the PV panels are configured to provide voltages within the unit's operating voltage window.
All of the unit's LEDs are off and the unit does not show up on the Xantrex XW SCP.	A. No battery connection to the unit. B. The unit is miswired. C. Failed unit.	A. Change the battery disconnect from the off position to the on position. B. Check all connections and correct the wiring if voltage is not present on the unit's battery terminals. C. If you have verified there is at least 20 V present on the unit's battery terminals yet the On/Charging (green) LED remains off, contact customer service.

Table 3-1 PV Charge Control Problems

Problem	Possible Cause	Solution
The unit's On/Charging (green) LED is flashing.	The unit is outputting charge current.	No problem. This is intended operation. See "Viewing Status Information on the Xantrex XW MPPT 80 600" in the Xantrex XW MPPT 80 600 Operation Guide for LED status information.

Replacing the Ground Fault Protection Fuse

⚠ DANGER

HAZARD OF ELECTRIC SHOCK

If a ground fault is indicated, normally grounded PV conductors could be ungrounded and energized. Before working on any portion of the array or wiring, make sure that portion of the array is de-energized by blanketing, use of disconnects, or other safe working procedures and by testing for voltage before beginning work.

Failure to follow these instructions will result in death or serious injury.

The ground fault protection fuse blows when a significant leakage current flows between the PV array and earth ground, or when the system has been installed with deficient wiring. Before replacing the fuse, it is important to have qualified service personnel, such as a certified electrician or technician, determine the cause of the ground fault and effect repair.

To replace the ground fault protection fuse:

1. Make sure the PV and battery disconnect switches are open and the unit is de-energized.
2. Remove the wiring compartment cover, as described on page 2–5.
The ground fault protection fuse is located behind the wiring terminals.
3. Remove the blown fuse and replace it with a new AC/DC midget cartridge, DC-rated 600 VDC, 1 A (Littelfuse KLKD 1 or equivalent). Be careful not to damage the fuse clips, circuit board, and surrounding components.
4. Replace the wiring compartment cover.
5. Clear the fault and reset the system by removing and then reapplying both PV and battery power.

Ground Faults in a Normally Ungrounded Array

DANGER

HAZARD OF ELECTRIC SHOCK

If a ground fault is indicated, normally grounded PV conductors could be ungrounded and energized. Before working on any portion of the array or wiring, make sure that portion of the array is de-energized by blanketing, use of disconnects, or other safe working procedures and by testing for voltage before beginning work.

Failure to follow these instructions will result in death or serious injury.

On a normally ungrounded (floating) array, the ground fault protection system indicates a fault when a short circuit or lower than normal resistance exists between the array and ground. Before resetting the fault and attempting to restart the system, it is important to have qualified service personnel, such as a certified electrician or technician, determine the cause of the ground fault and effect repair.

To mitigate a ground fault in a normally ungrounded array:

1. Make sure the PV and battery disconnect switches are open and the unit is de-energized.
2. Search or troubleshoot for a ground fault on the PV array (for example, a broken PV panel or pinched PV wire).
3. Clear the fault and reset the system by removing and then reapplying both PV and battery power.

A

Specifications

Appendix A provides the specifications for the Xantrex XW MPPT 80 600.

For information on:	See:
"Electrical Specifications"	page A-2
"Default Battery Charger Settings"	page A-4
"Mechanical Specifications"	page A-5
"Optional Accessories"	page A-6
"Regulatory Approvals"	page A-6

All specifications are subject to change without notice.

Electrical Specifications

Maximum PV Array Open Circuit Voltage	600 VDC
PV Array Voltage Operating Range	195 to 550 VDC
PV Array Voltage Full Power Range ^a	230 to 550 VDC
Maximum Power Point Tracking Range	195 to 510 VDC
PV Array Start Voltage	230 VDC
PV Input Current Limit	23 ADC (electronically limited)
Maximum Permissible PV Short Circuit Rated Current	28 ADC @ STC
Nominal Battery Voltages	24 and 48 VDC (Default is 48 V)
Battery Voltage Operating Range	16 to 67 VDC
Maximum Charging Current	80 A
Maximum Charging Power	2560 W (nominal 24 V battery bank) 4800 W (nominal 48 V battery bank)
Maximum Power Conversion Efficiency	94% (nominal 24 V battery bank) 96% (nominal 48 V battery bank)
Auxiliary Output	Dry contact switching up to 60 VDC, 30 VAC, 8 A
Charger Regulation Method	Three stage (bulk, absorption, float) Two stage (bulk, absorption)
Tare Losses ^b	less than 1.0 W (Xantrex Xanbus power supply on) less than 0.5 W (Xantrex Xanbus power supply off)

a. Full power output below 230 V is not assured. See "Operating Below the PV Array Voltage Full Power Range" on page A-3 for more information.

b. These values are based on the following specifications:

- The battery voltage is 48 V.
- The auxiliary power supply is shut off at night. See "Disabling Power Supplies at Night" in the Xantrex XW MPPT 80 600 Operation Guide for more information.

MPPT Voltage Range

The unit's Maximum Power Point Tracking (MPPT) algorithm maximizes the output energy of PV arrays as long as the operating voltage is within the MPPT operational window. Make sure that the PV arrays used in the system operate within the MPPT operational window. The operational window is shown below.

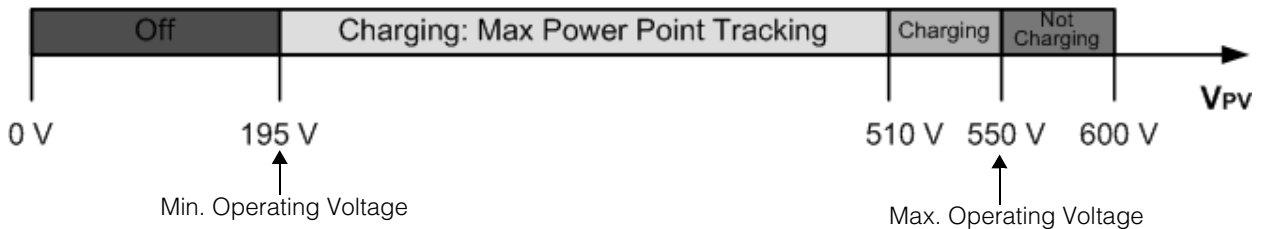

Note:
 Max VOC 600 V
 Input Current limit 23 A
 Output current limit 80 A

Figure A-1 MPPT Operational Window

Operating Below the PV Array Voltage Full Power Range

When the unit is operating on a 48 V battery bank and a PV array where the MPP is below 230 V, full output power is not assured. Figure A-2 and Figure A-3 show the maximum output current and maximum output power that can be produced when the unit is operating below 230 V. Note that the actual amount of current and power that your unit can produce below 230 V will depend on the actual battery voltage and the amount of solar power available from your panels. Full output current is available on 24 V battery systems across the entire input voltage operating range.

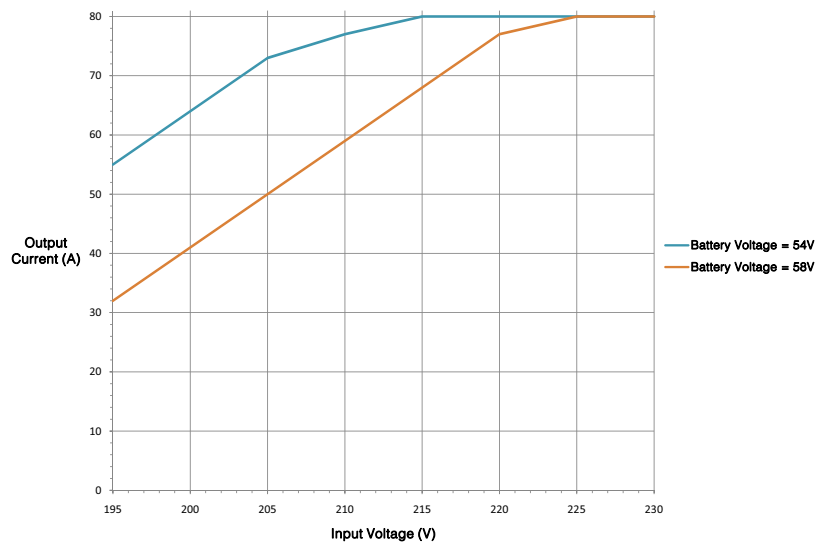

Figure A-2 Maximum Expected Output Current Versus Input Voltage

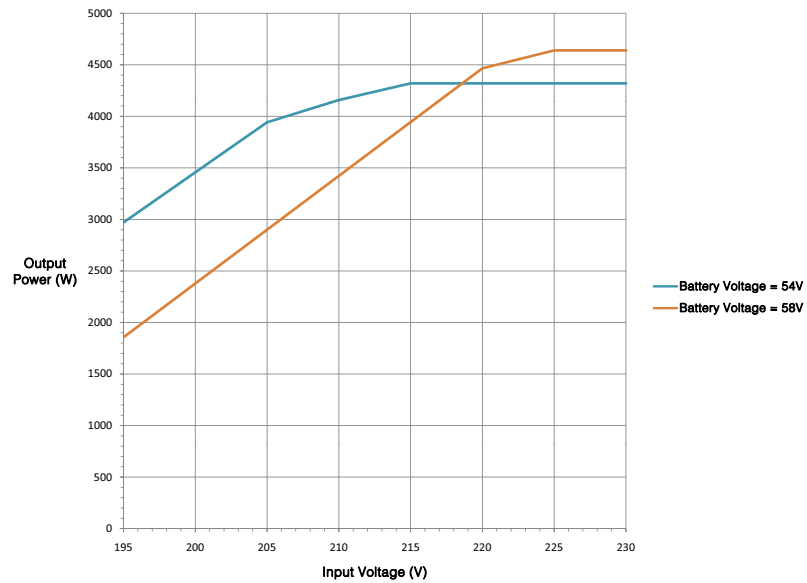

Figure A-3 Maximum Expected Output Power Versus Input Voltage

Default Battery Charger Settings

All settings in the following table are based on a 48 V nominal battery bank. For a 24 V nominal battery bank, divide the voltage values in this table by two.

Setting	Battery Type		
	Flooded ^a	Gel	AGM
Equalize Voltage	64.0 V	n/a	n/a
ReCharge Voltage	50.0 V	50.0 V	50.0 V
Bulk Voltage	57.6 V	56.8 V	57.2 V
Absorption Voltage	57.6 V	56.8 V	57.2 V
Float Voltage	54.0 V	55.2 V	53.6 V
Absorption Time	360 min	360 min	360 min
Batt Temp Comp	-108 mV/C	-108 mV/C	-84 mV/C

a. When Custom is selected for the battery type, the default settings are based on the flooded battery type.

Mechanical Specifications

Enclosure Type	IP20, indoor, ventilated, aluminum sheet metal chassis with 7/8" and 1" (22.22 mm and 27.76 mm) knockouts and aluminum heat sink
Maximum and Minimum Wire Size in Conduit	#6 AWG to #14 AWG (13.5 to 2.5 mm ²)
Maximum and Minimum Wire Size Rating of PV Terminal Block	#6 AWG to #14 AWG (13.5 to 2.5 mm ²)
Maximum and Minimum Wire Size Rating of Battery Terminal Block	#2 AWG to #14 AWG (35 to 2.5 mm ²)
Wire Size Rating of Auxiliary Output Connector	#16 AWG (1.5 mm ²)
Operating Temperature Range (derate above 45 °C)	-20 to +65 °C (-4 to 149 °F) (output power to be derated linearly to zero at 65 °C)
Storage Temperature	-40 to +85 °C (-40 to 185 °F)
Altitude Limit (operating)	Sea level to 6,500 feet (approximately 2000 m)
Dimensions (H × W × D)	30 × 8 5/8 × 8 5/8" (760 × 220 × 220 mm)
Mounting	Vertical wall mount
Weight (Controller only)	29.8 lb (13.5 kg)
Weight (Shipping)	38.3 lb (17.4 kg)

Recommended Accessories

The Xantrex XW System Control Panel (865-1050) is required for installation of the unit, and it is strongly recommended for continued operation of the unit. It is the primary interface to the unit. It must be used for setup and configuration, and it is recommended to be used for monitoring and fault reporting once installation is complete. Only one Xantrex XW SCP is required to monitor multiple units.

Important: You must use a Xantrex XW SCP with firmware version 1.03.00 or higher for full compatibility with the unit. For information on updating your firmware, contact customer service (see "Contact Information" on page ii). The Xantrex XW Config tool will be required.

Optional Accessories

Xantrex Gateway	865-1055
Xantrex Xanbus power supply	865-1057
Xantrex XW Config (Provides the ability to update system firmware and monitor system status. See "Xantrex XW Config User's Guide" Part Number 975-0365-01-01)	865-1155

Regulatory Approvals

Certified to UL 1741 and to CSA 107.1 and carries the c(CSA)us mark.

EMC - North America:

- FCC Part-15 sub part B, Class B
- Industry Canada ICES-003, Class B

CE Marked and complies with the following:

Low Voltage Directive 2006/95/EC, per:

- EN50178 *Electronic Equipment for Use in Power Installations.*

EMC Directive 2004/108/EC, per:

- EN61000-6-3 *Emission standard for residential, commercial, and light-industrial environments*
- EN61000-6-1 *Immunity for residential, commercial, and light-industrial environments*

Index

A

- abbreviations iv
- accessories
 - optional A-6
 - recommended A-5
- acronyms iv
- auxiliary output
 - connections 2-15
 - vent fan application 2-16

B

- batteries
 - charging current 1-2
 - default charger settings A-4
 - over-current protection 2-11
 - requirements 1-2
 - safety information viii
 - sealed 2-3
- battery temperature sensor
 - attaching to battery terminal 2-20
 - installation diagram 2-20
 - installing 2-19
 - overview 2-19
 - using multiple 2-19

C

- cables, network 2-17
- CAUTION, definition iv
- charge controlling
 - charging current 1-2
 - overview 1-2
 - three-stage 1-2
 - two-stage 1-2
- charger settings
 - configuring 2-22
 - default A-4
- chassis grounding 2-8
- clearance requirements 2-4
- commissioning
 - charger settings 2-22
 - connections 2-22
 - copying settings 2-23
 - multiple units 2-21
 - overview 2-21

- setting device number 2-21
- single unit 2-21
- configuring
 - charger settings 2-22
 - connections 2-22
- connecting
 - multiple PV array strings 2-13
 - multiple units 2-13
 - network cables between multiple units 2-18
 - single unit, floating system 2-13
 - single unit, negative-grounded system 2-12
 - single unit, positive-grounded system 2-13
- connections, auxiliary output 2-15
- copying settings 2-23
- current rating 2-10

D

- DANGER, definition iii
- DC terminal connector locations 2-9
- device number, setting 2-21
- disconnecting the unit 2-16

E

- electrical specifications A-2

F

- FCC information viii
- features 1-2
- floating PV system 2-8
- fuse holders, ground fault protection 2-8
- fuses, replacing 3-4

G

- Gateway. *See* Xantrex Gateway
- ground fault protection 3-4
 - fuse holders 2-8
 - normally ungrounded array 3-5
 - overview 2-8
 - replacing fuse 3-4
- grounding
 - chassis 2-8
 - PV. *See* PV grounding

I

installing battery temperature sensor 2-19
interference, radio and television reception viii

K

knockouts
 dimensions 2-7
 locations 2-7
 overview 2-6
 removing 2-6

L

Lexan barrier 2-5
limitations on use vii
location
 choosing 2-3
 minimum clearance requirements 2-4

M

maximum power point tracking voltage range A-3
mechanical specifications A-5
minimum
 clearance requirements 2-4
 wire gauge 2-10
mounting
 instructions 2-7
 orientation 2-3
MPPT voltage range A-3
multiple PV array strings 2-13
multiple units
 commissioning 2-21
 connecting 2-13
 connecting network cables 2-18
 copying settings 2-23
 DC wiring diagram 2-15

N

negative-grounded PV system 2-8
network
 cables 2-17
 components 2-17
 diagram 2-18
 installation 2-16
 layout 2-18
 ordering components 2-17
 terminators 2-17
normally ungrounded array, ground fault protection
 3-5
NOTICE, definition iv

O

optional accessories A-6
ordering network components 2-17
over-current protection
 battery circuit 2-11
 PV 2-11
 requirements 2-11

P

positive-grounded PV system 2-8
power supply, Xantrex Xanbus 2-17
PV array
 requirements 2-2
 sizing 2-2
PV disconnect switch 2-11
PV grounding
 floating 2-8
 negative 2-8
 overview 2-8
 positive 2-8
 ungrounded 2-8
PV input current rating 2-10

Q

qualified personnel, requirements iii

R

radio reception interference viii
reception interference viii
recommended accessories A-5
regulatory approvals A-6
removing
 knockouts 2-6
 wiring compartment cover 2-5
replacing the fuse 3-4
requirements, PV array 2-2
reverse polarity damage 2-12

S

safety information
 batteries viii
 general vii
SCP. *See* Xantrex XW System Control Panel
sealed batteries, mounting with 2-3
sizing, PV array 2-2
specifications
 electrical A-2
 mechanical A-5

T

television reception interference viii
terminators, network 2–17
three-stage charge controlling 1–2
troubleshooting 3–2
two-stage charge controlling 1–2

U

ungrounded PV system 2–8

W





WARNING, definition iii
wire gauge, minimum 2–10
wiring
 DC terminal connector locations 2–9
 diagram 2–14
wiring compartment
 Lexan barrier 2–5
 removing cover 2–5

X

Xantrex Gateway 1–2
Xantrex Xanbus
 network installation 2–16
 overview 2–16
 power supply 2–17
 See also network
Xantrex XW System Control Panel 1–2

Schneider Electric

www.schneider-electric.com

			
North America	1 650 351 8237 1 866 519 1470	1 925 245 1022	re.techsupport@schneider-electric.com
France	0 825 012 999		fr-re-techsupport@fr.schneider-electric.com
Deutschland	+49 (0) 180 575 3 575	+49 (0) 2102 404 7101	pv-service@de.schneider-electric.com
España	+34 902 101 813	+34 933 055 026	es-sat@es.schneider-electric.com
L'Italia	+39 035 4151111	+39 035415 3200	IT-pronto-contatto@it.schneider-electric.com

For other country details please contact your local Schneider Electric Sales Representative or visit our website at: <http://www.schneider-electric.com/sites/corporate/en/support/operations/local-operations/local-operations.page>.